

## E55 Touch Panel (RGBWY)



Manual  
www.ltech-led.com

## System Diagram

### L-BUS

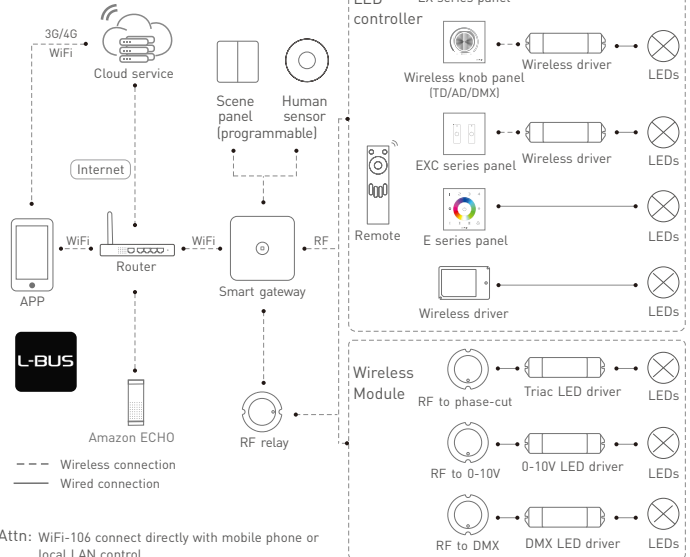

Attn: WiFi-106 connect directly with mobile phone or local LAN control.

WiFi-108 can be controlled by remote or local LAN, and supports ECHO amazon voice speakers.  
The E series panel does not support advanced mode when work with WiFi-108.

## Product Features

- 2 in 1 function: RF wireless control and PWM power output.
- Power output, lamps can be connected directly, easy and convenient.
- RGB, RGBW, RGB+CT LED lights can be controlled.
- Touch keys with chord and LED indicator.
- Panel adopts capacitive touch control technology, makes LED color selection more user-friendly.
- Touch panel can be controlled by remote directly or smart phone if add a gateway.

## Technical Specs

Model: E5S

Input Voltage: 12-24Vdc

Wireless Frequency: RF 2.4GHz

Current Load: RGB: 3A×3CH CT: Max. 3A

Output Power: RGB: [0~36W...72W]×3CH CT: 0~36W...72W

Unit: mm

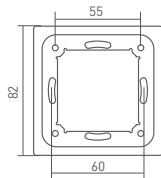
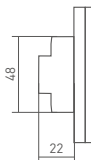
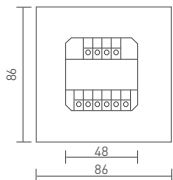

# LTECH

## Installation Instruction

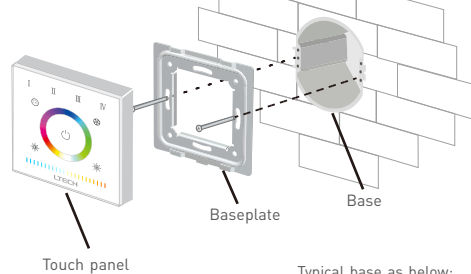

# LTECH

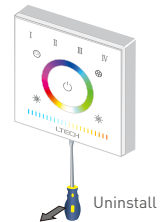

Typical base as below:

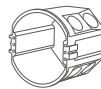

European style

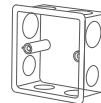

86 size

## Terminals



12-24Vdc  
Power Input

LED Lamps  
Connection

# Key Functions

## Scene-mode

Short press: play  
Long press: save

## Speed

## ON/OFF

## CT brightness

Press: on/off  
Long press: brightness

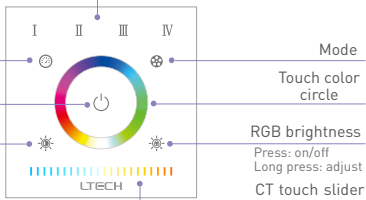

## Mode

1. Red green jumping
2. Green blue jumping
3. Red blue jumping
4. RGB jumping
5. 7 colors jumping
6. Red green smooth
7. Green blue smooth
8. Red blue smooth
9. RGB smooth
10. 7 colors smooth

## Touch color circle

## RGB brightness

Press: on/off  
Long press: adjust

## CT touch slider

\* When blue indicator light of key is on, long press to turn on/off buzzer.  
When white indicator light of key is on, long press to match code.



# Application Composition

1. Touch panel + Lamps
2. Remote + Touch panel + Lamps
3. WiFi master controller + Touch panel + Lamps
4. WiFi master controller + Remote + Touch panel + Lamps

# LTECH

# System Diagram

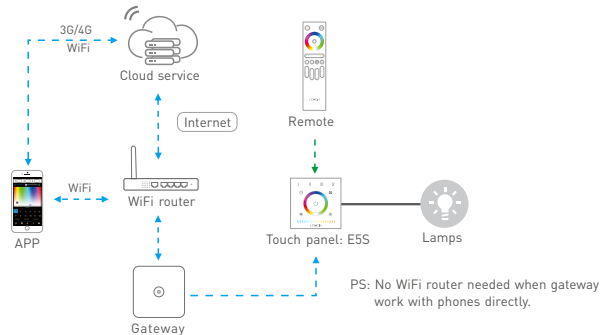

# LTECH

# RF Wireless Wiring



\* Touch panels can be sync controlled by multi remotes, please refer to the manual of remote's usage.

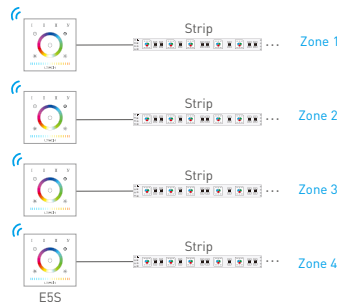

## Wiring Diagram

LTECH

Connect with 12V strip, RGB Max. 108W, CT Max. 36W.

Connect with 24V strip, RGB Max. 216W, CT Max. 72W.

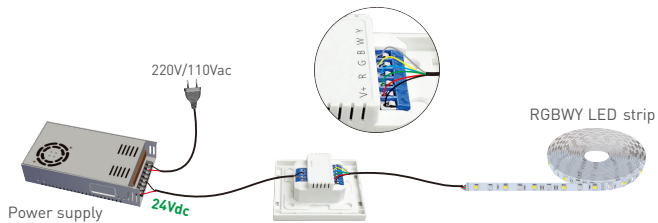
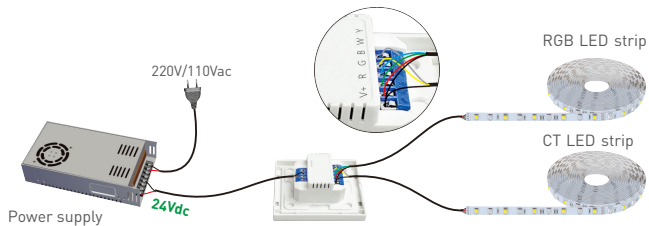

## Match Code between Touch Panel & Remote

LTECH

1.

Long press  on touch panel until all scene's indicator lights flicker.



2.

Long press the matching zone's "ON" key on Q5, the indicator light of panel stop flicking, match successfully.



## Match Code between Touch Panel & Gateway

1.

Long press  on touch panel until all scene's indicator lights flicker.



2.

Turn on APP, enter "zone set" interface, click the right top "MATCH" key, then follow the prompts.



## Clear Code



Press the bottom two key on touch panel simultaneously for 5 seconds, the indicator light flicker several times, clear code successfully.

\* Please match/clear code when panel is on (white indicator light of  key is on).

\* No further notice if any changes in the manual. Product function depends on the goods. Please feel free to contact your supplier if any question.